

# Design Patent Illustration Example

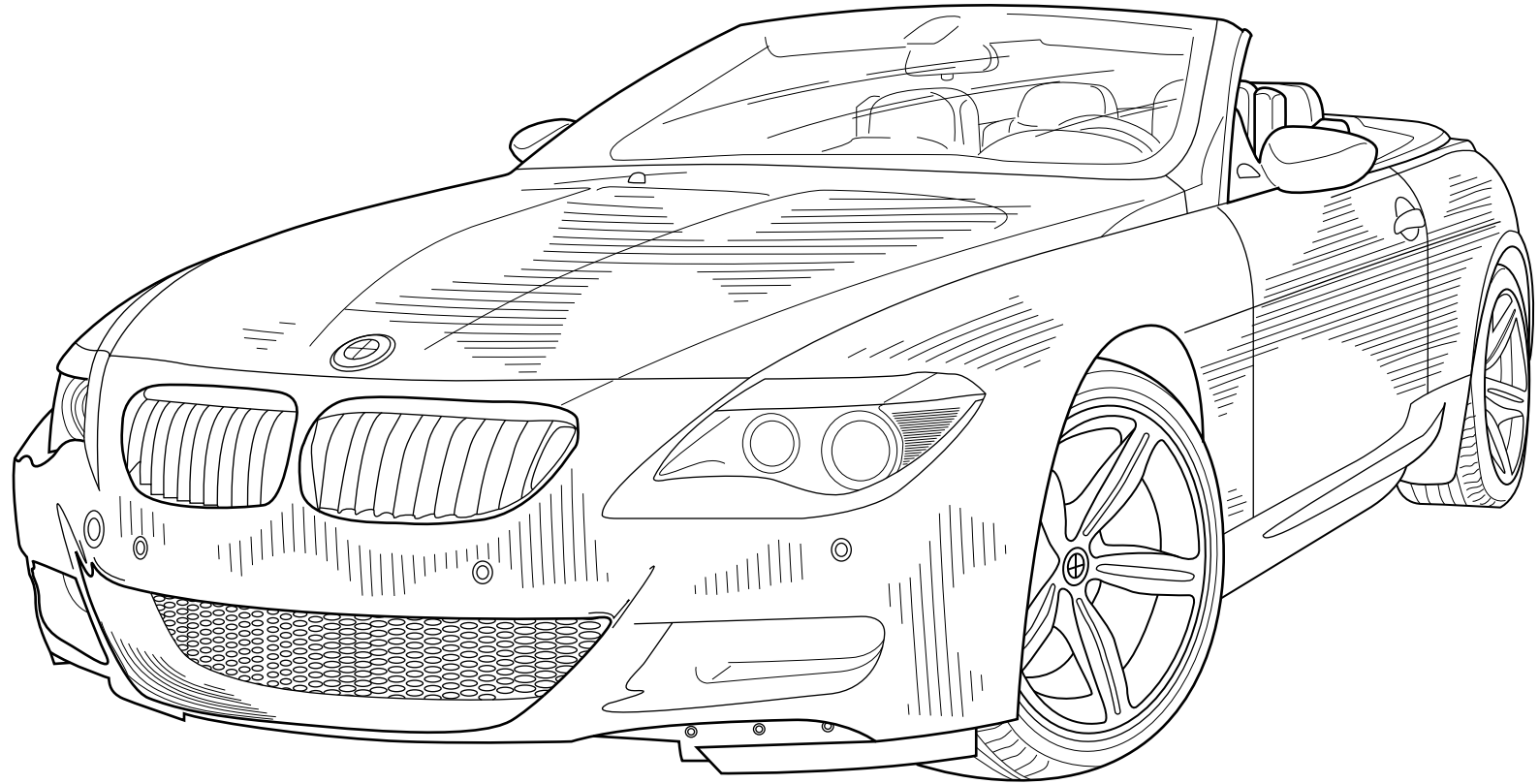

FIG. 6A

# Design Patent Illustration Example

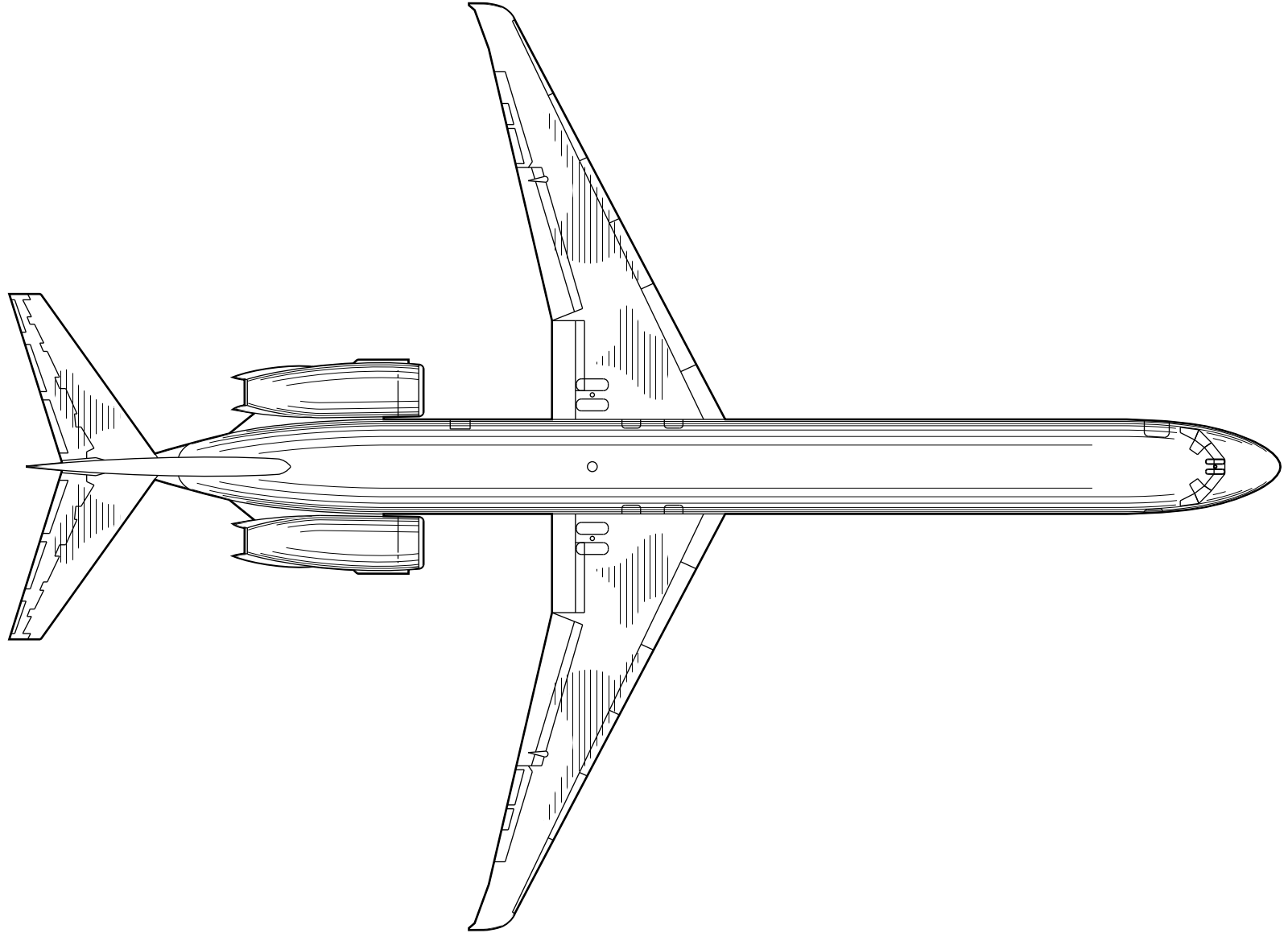

FIG. 6B

# Design Patent Illustration Example

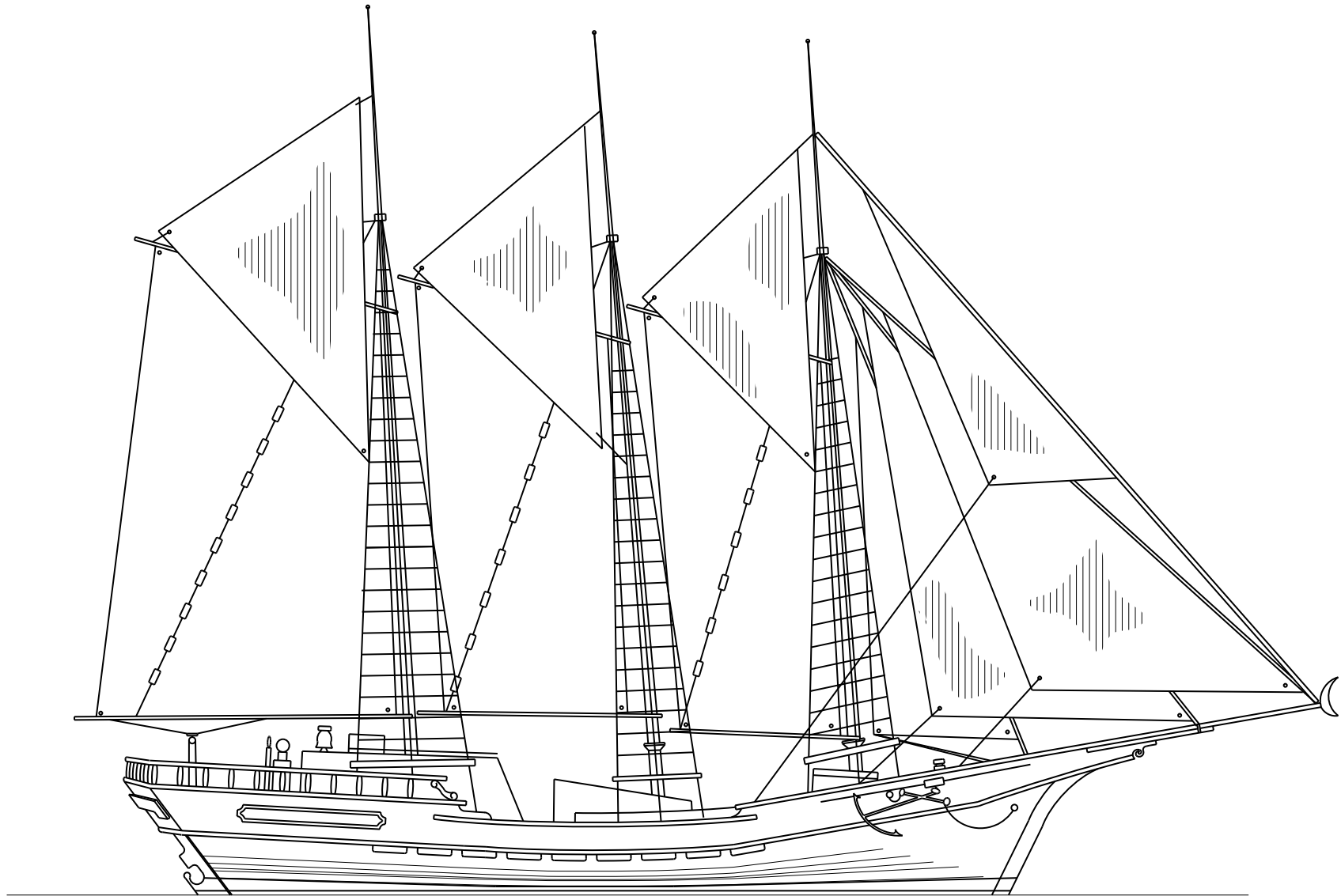

FIG. 6C

# Design Patent Illustration Example

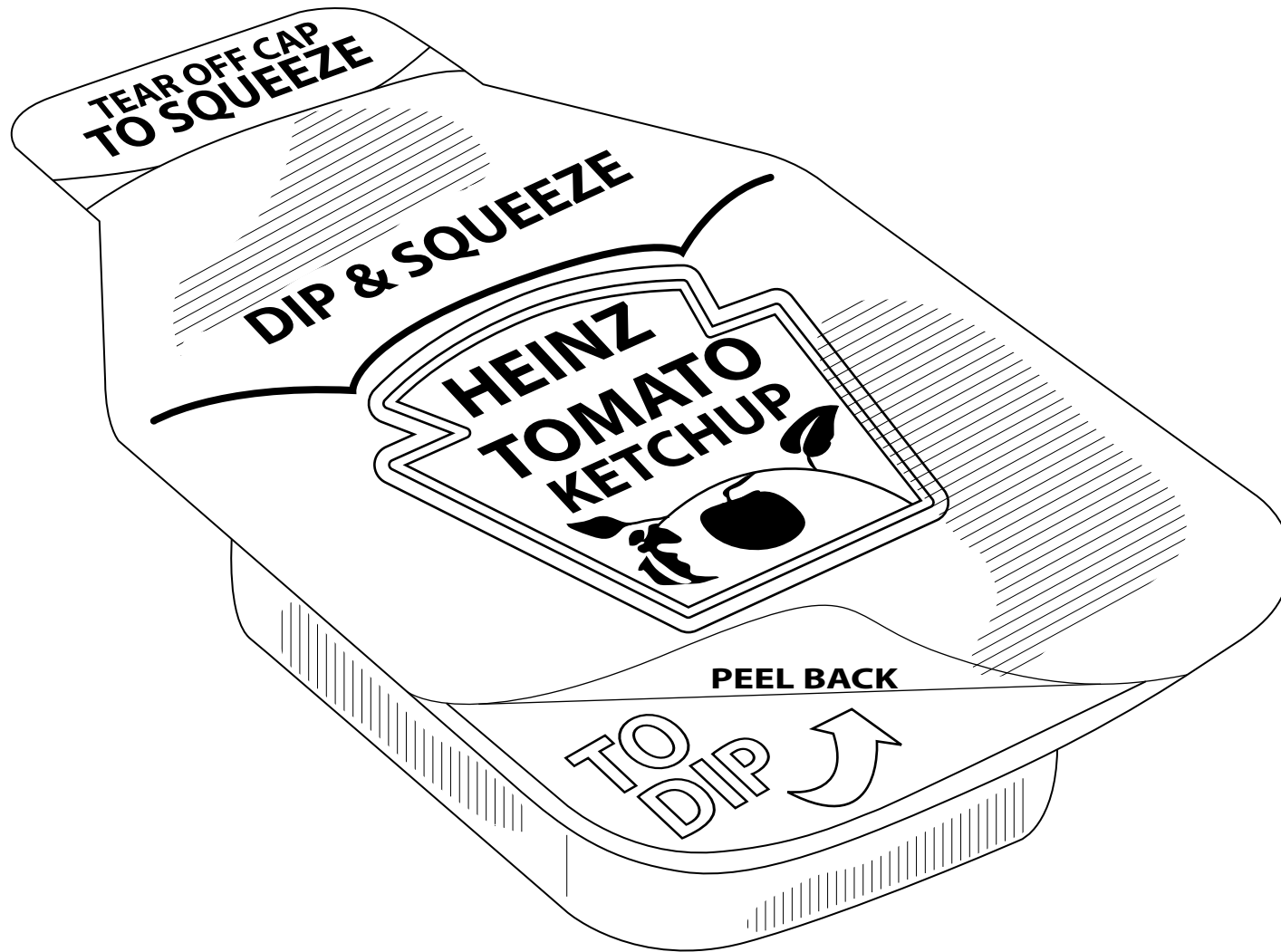

FIG. 7A

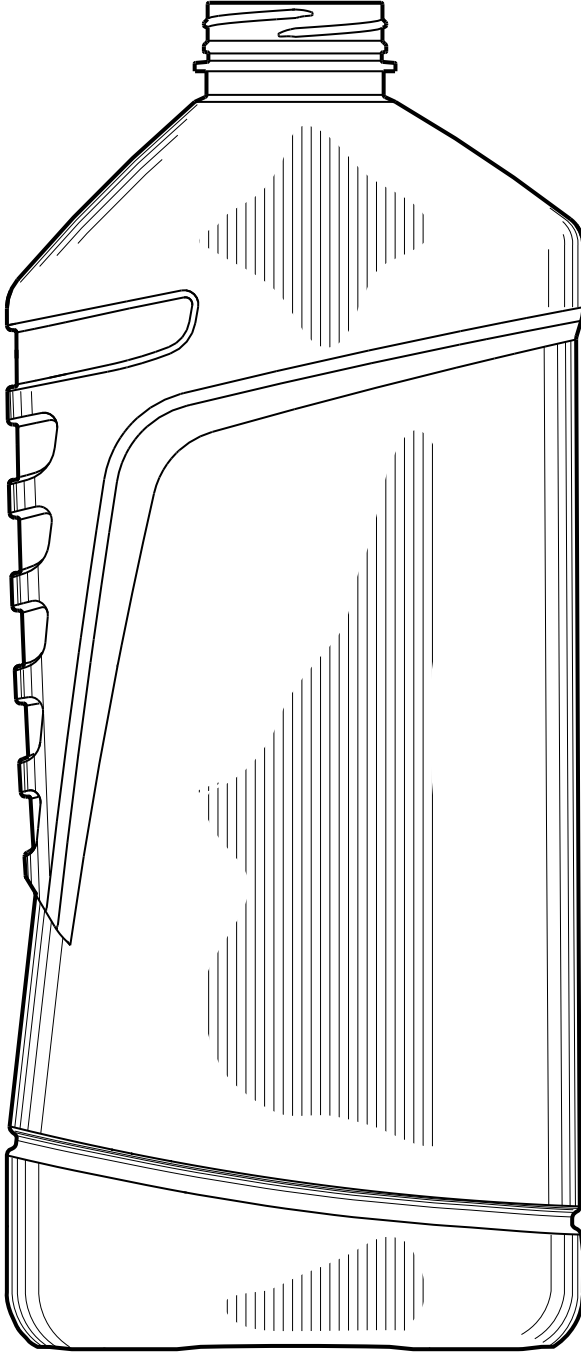

FIG. 7B

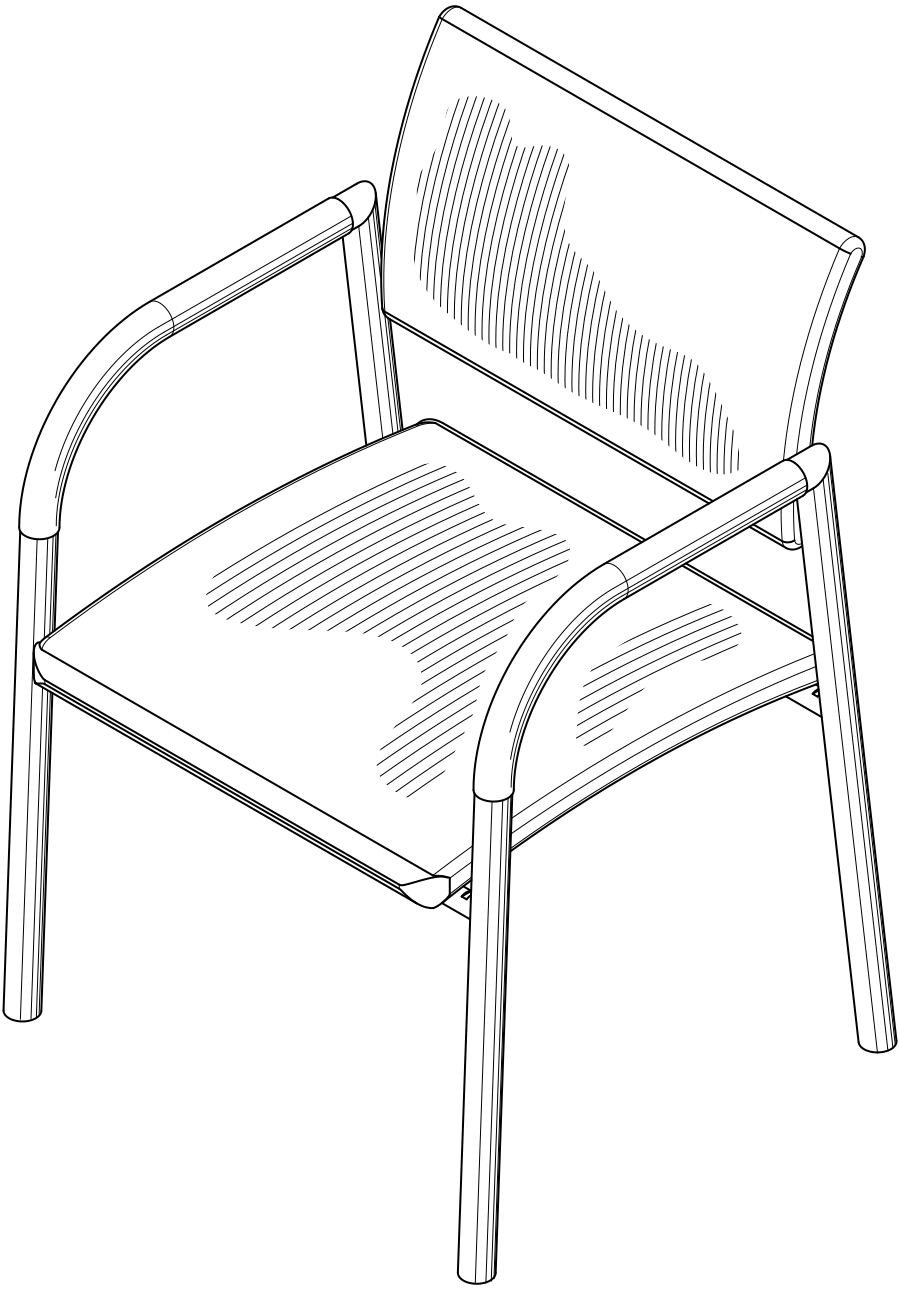

FIG. 7C

# Design Patent Illustration Example

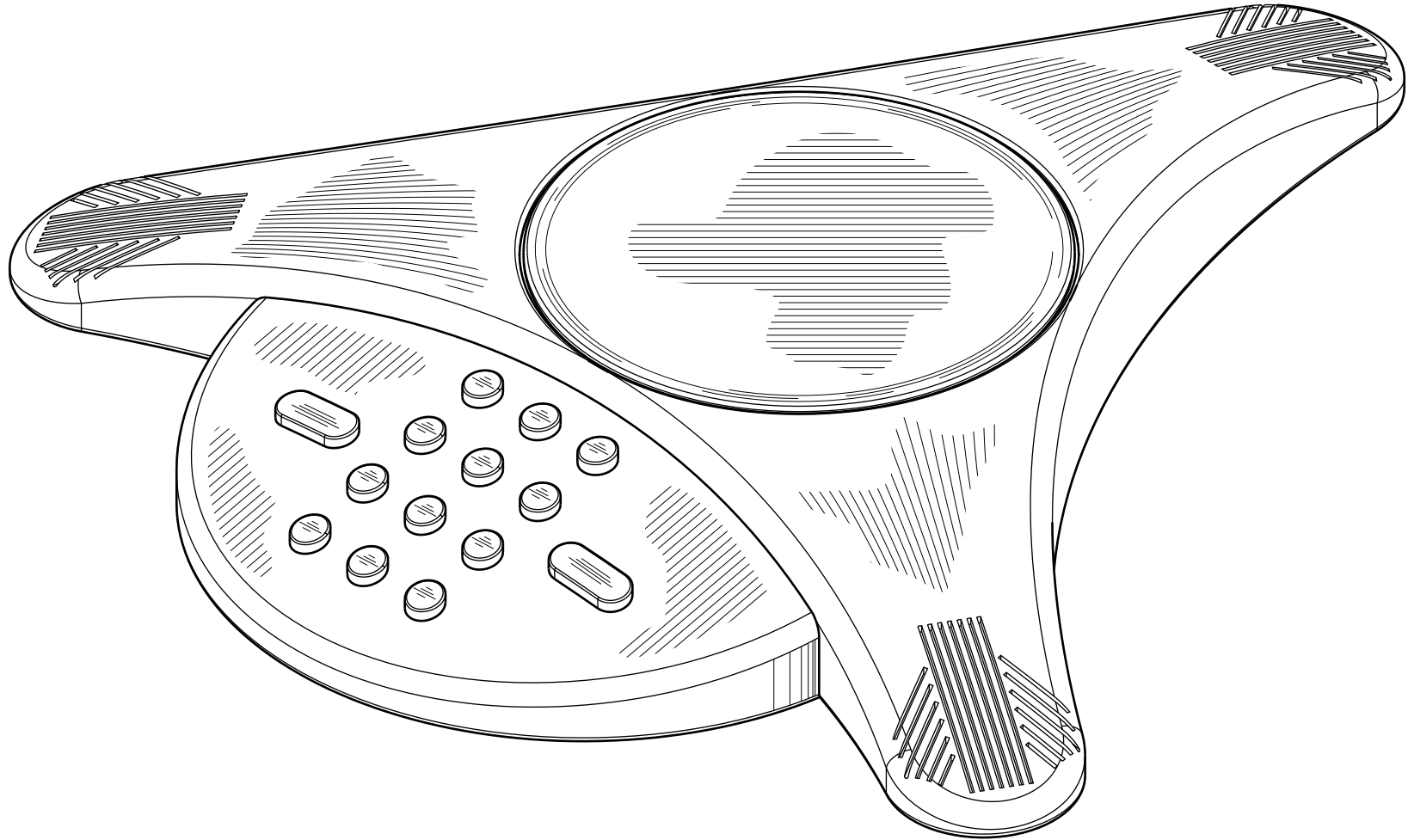

FIG. 8A

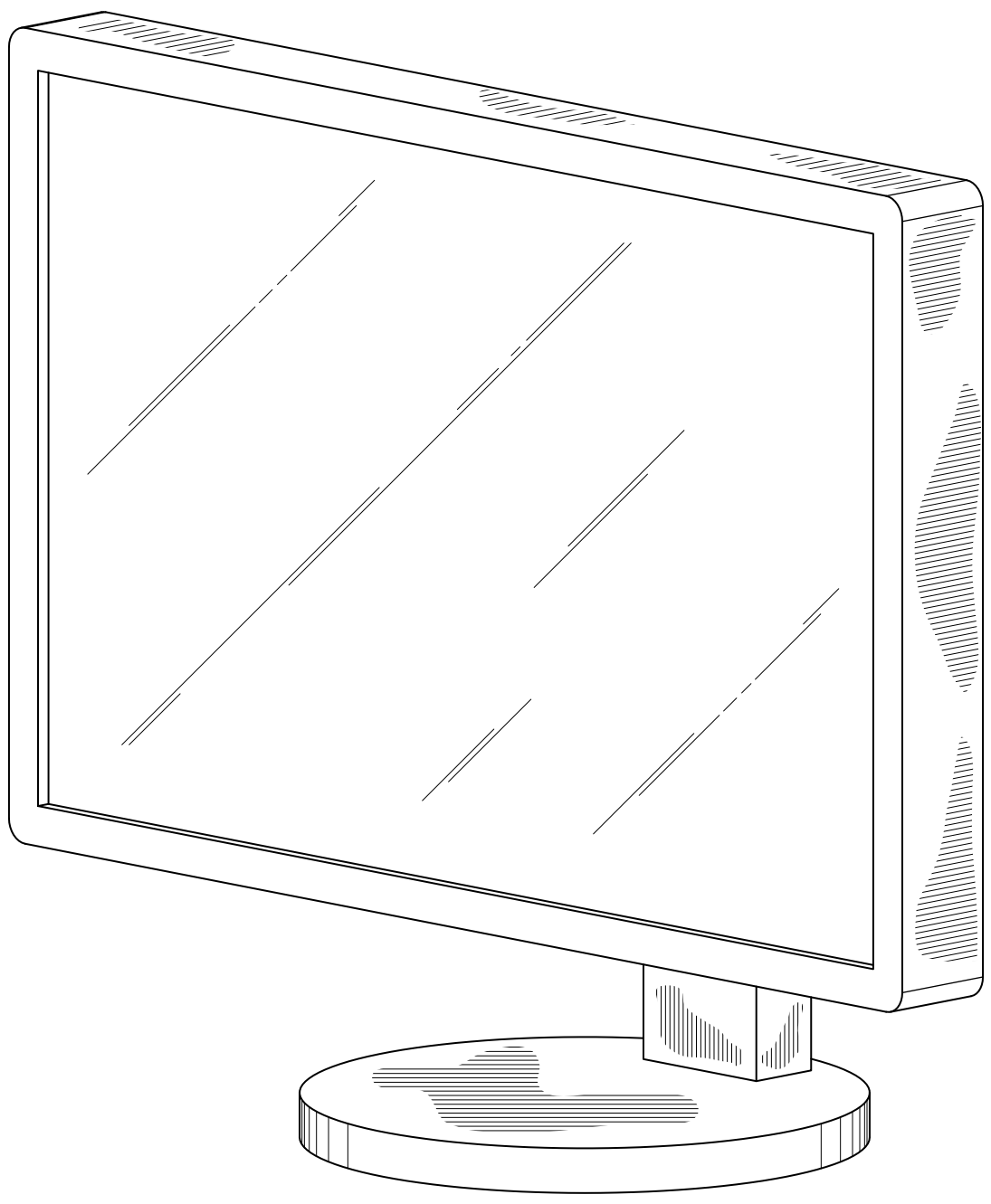

FIG. 8B



# Design Patent Illustration Example

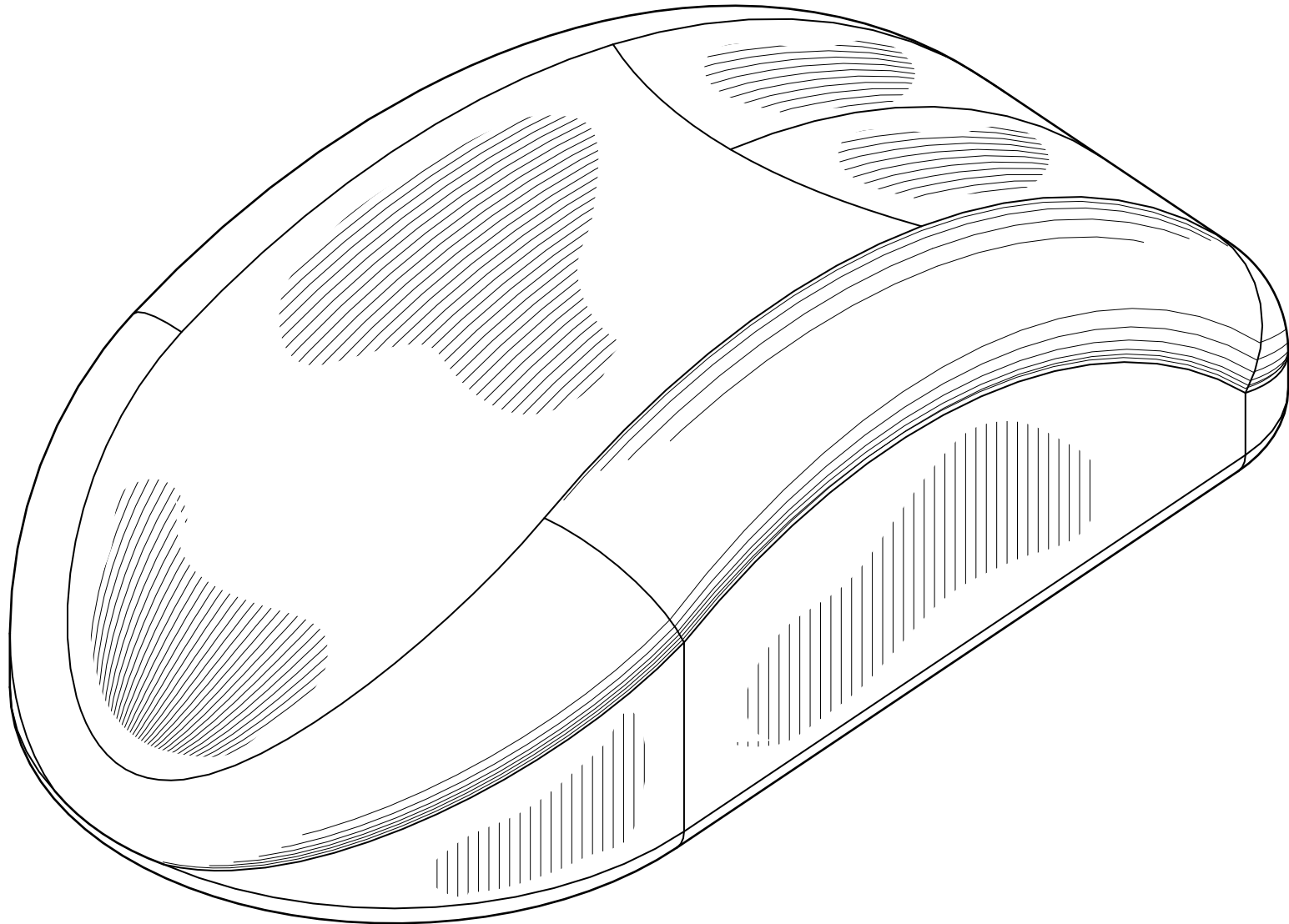

FIG. 8C

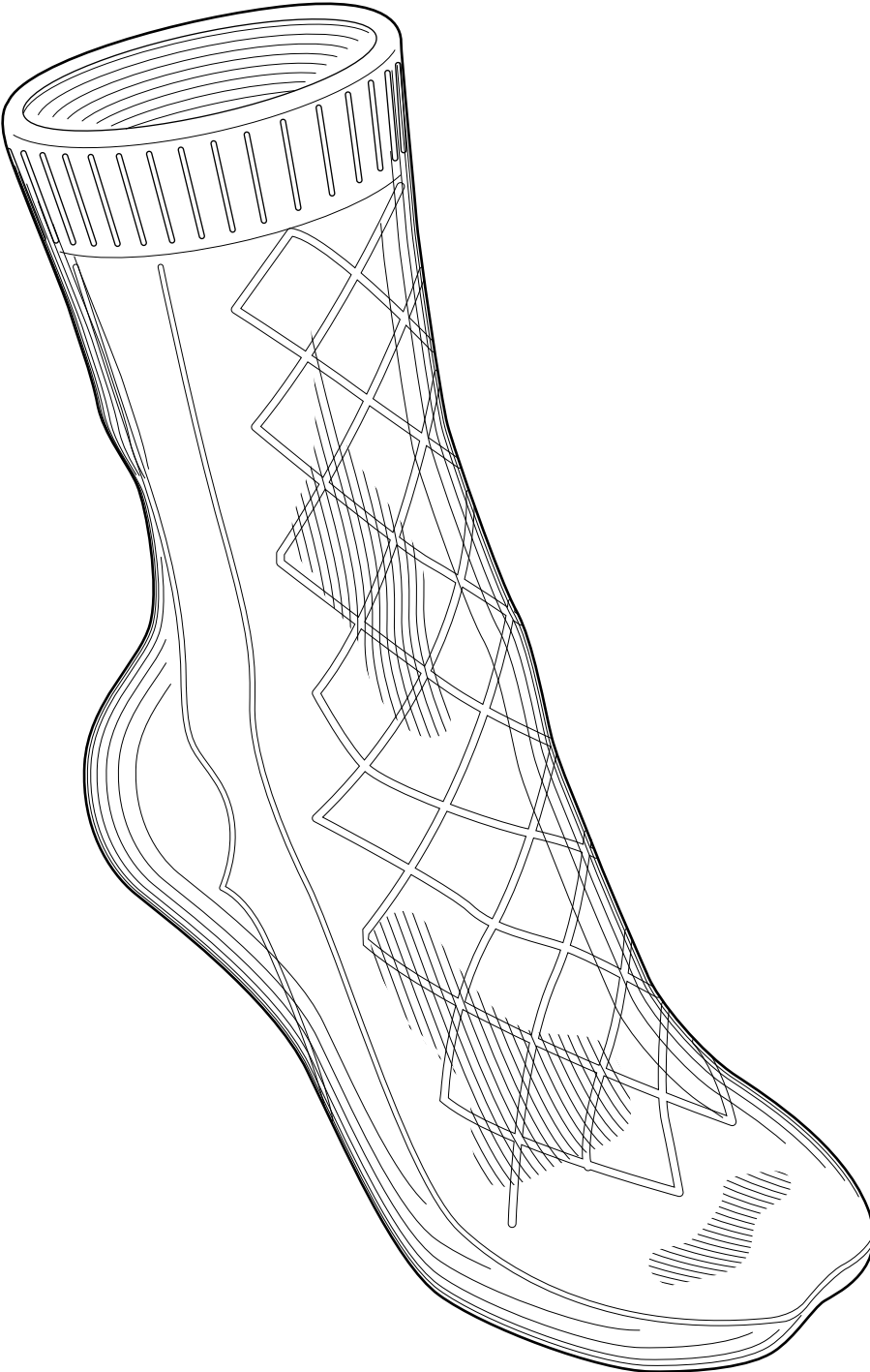

FIG. 9A



FIG. 9B

# Design Patent Illustration Example

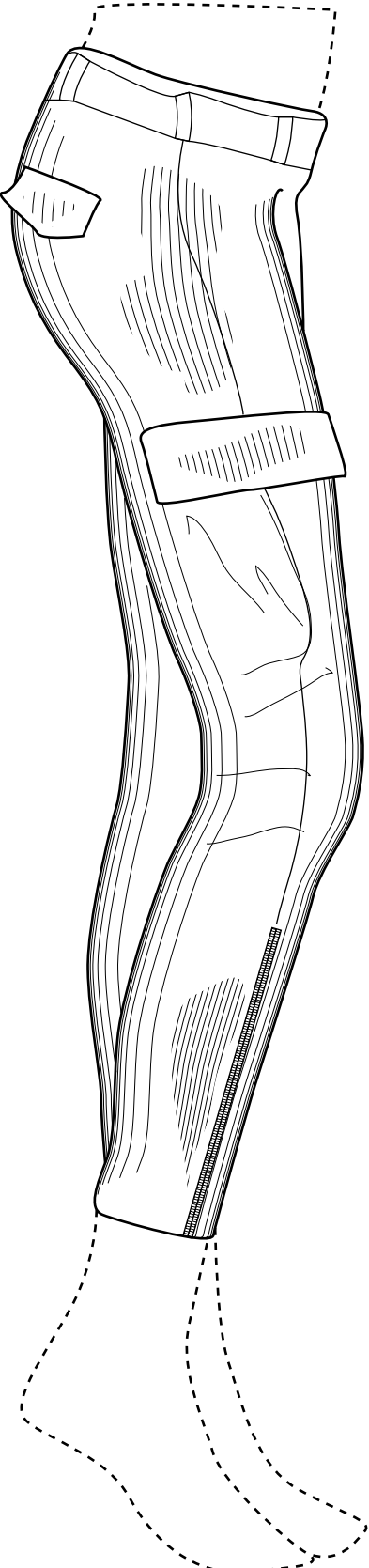

FIG. 9C

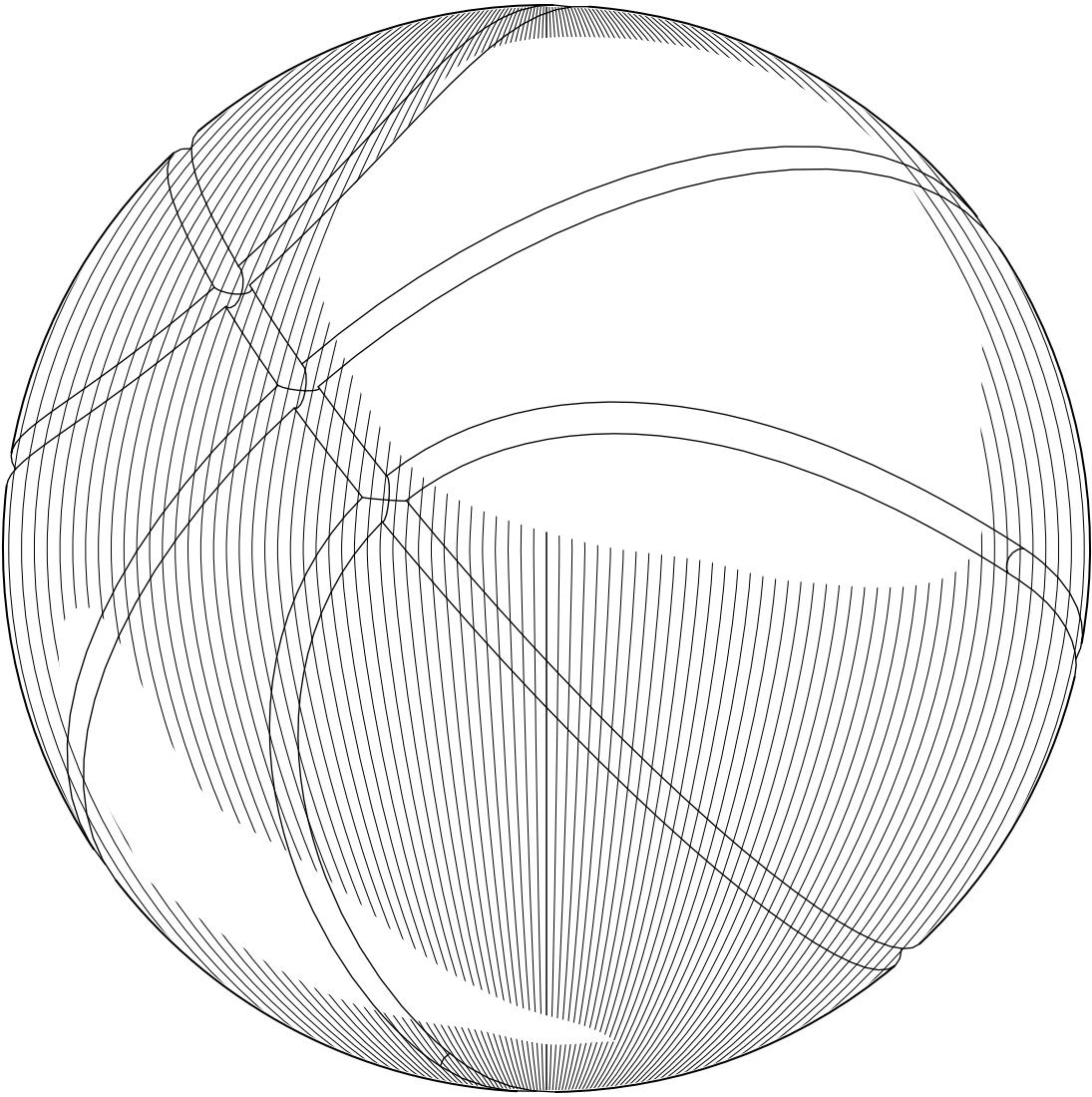

FIG. 10A

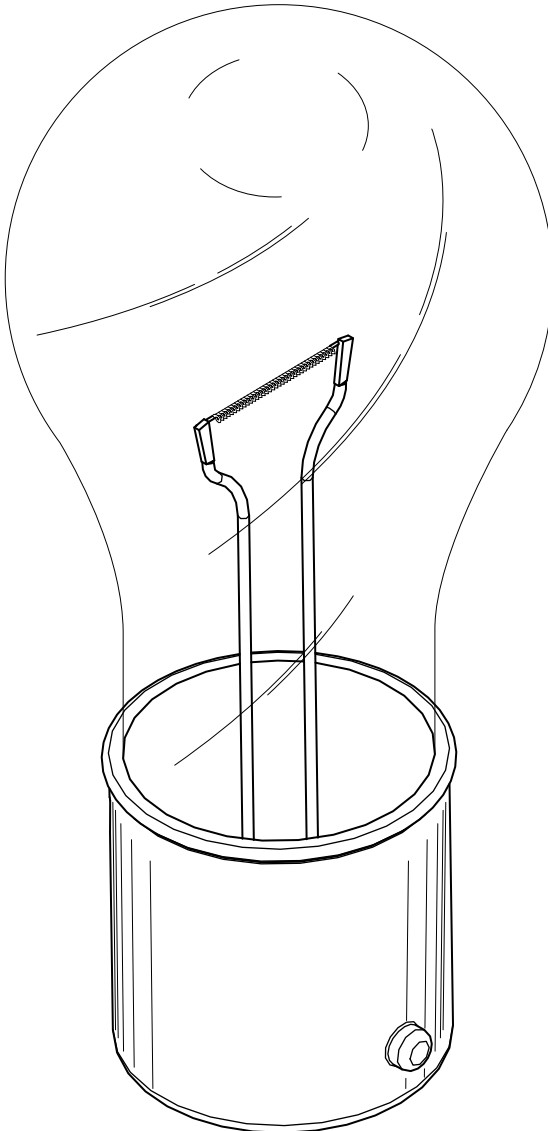

FIG. 10B

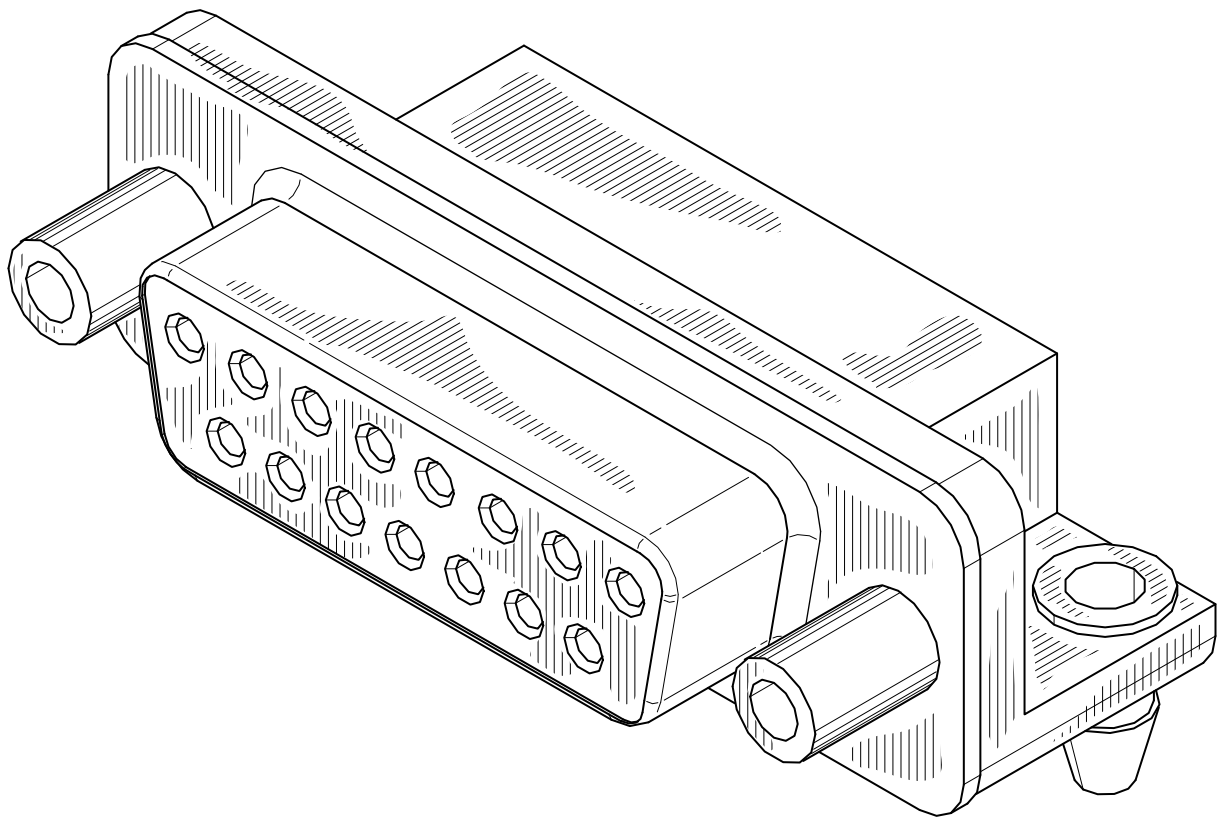

FIG. 10C